

WIPER[®] PST

EBR FFP MOA RETICLES

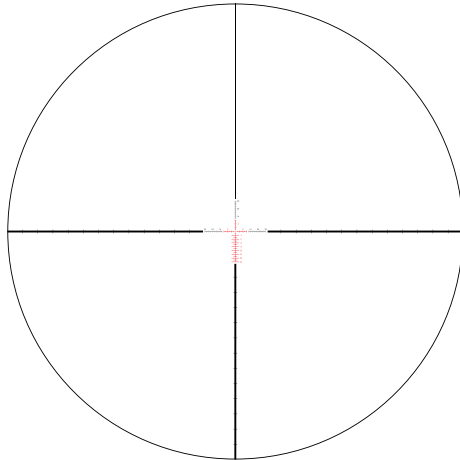



EBR-4 FFP 2-10 X 32

Shown at minimum magnification

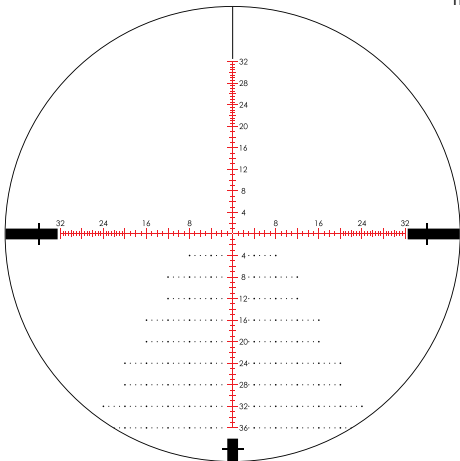

EBR-2C FFP 3-15 X 44

VORTEX[®] FIRST FOCAL PLANE EBR MOA RETICLES

Designed to maximize long-distance shooting and ranging abilities, the EBR MOA reticles can be used to effectively determine ranges, holdovers, windage corrections and moving target leads. Ultra-precision laser etching on the glass reticle ensures that MOA specifications are kept to the tightest tolerances possible. The fine center crosshair subtensions on the EBR MOA reticle were carefully chosen to provide the optimum balance between precision aiming and low light visibility. Includes windage reference dots on drop lines.

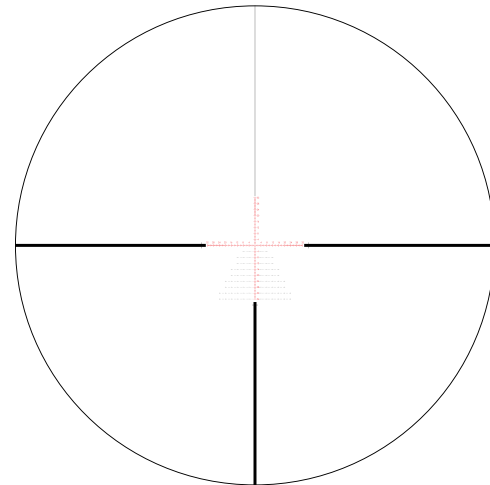

EBR-2C FFP 5-25 X 50

Note: Reticle images shown in this manual are for representation only—images vary between scope models depending on magnification and reticle plane.

MOA SUBTENSIONS

The EBR reticles are based on minute-of-angle (MOA) subtensions. MOA measurements are based on degrees and minutes: 360 degrees in a circle, 60 minutes in a degree for a total of 21,600 minutes. These angular measurements are used to estimate range and correct for bullet trajectory drop in riflescopes.

A minute of angle will subtend 1.05 inches at a distance of 100 yards (29.1 mm at 100 meters). Viper PST riflescopes with MOA adjustments use .25 minute clicks which subtend .26 inches at 100 yards (7.3 mm at a 100 meters), .52 inches at 200 yards (14.6 mm at 200 meters), .78 inches at 300 yards (21.9 at 300 meters), etc.

In the Viper PST first focal plane riflescopes, the listed MOA subtensions of the EBR reticles are valid at all magnification levels. This means the shooter can use the magnification level most appropriate for the situation and still have effective holdover and windage reference marks. This is also extremely valuable in a high-stress situation, as the shooter does not have to remember to set the scope to one particular magnification to get valid holdovers—an action necessary with the more common second focal plane reticles.

Estimating MOA

Although 1 MOA is very commonly corresponded to 1 inch at 100 yards, this is not quite correct: 1 MOA at 100 yards equals 1.05 inches. Calling 1 MOA an inch per 100 yards may be acceptable at shorter distances, but it will cause a five percent error in ranging and holdover adjustments. This will result in missed shots at longer distances.

Reticle Subtensions

2-10 x 32 EBR-4

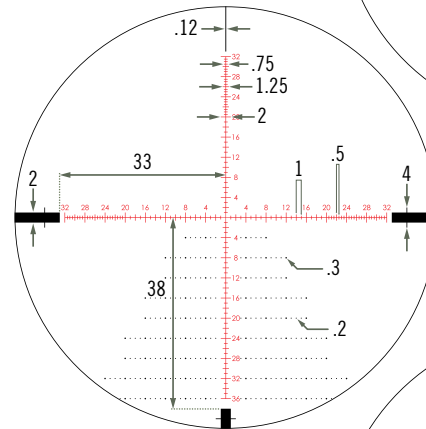
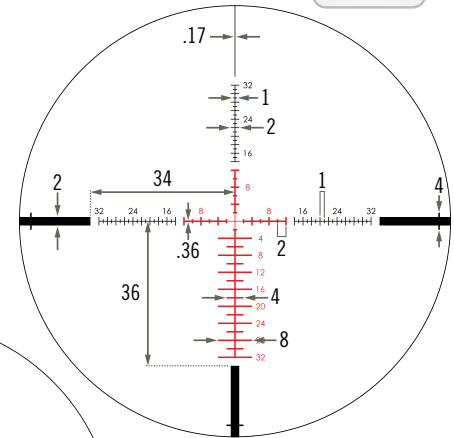

3-15 x 44 EBR-2C

5-25 x 50 EBR-2C

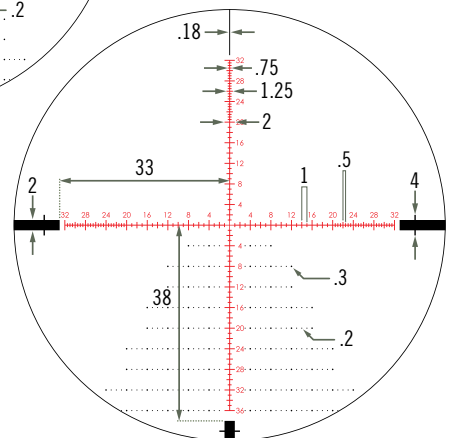

RANGING

MOA reticles are effective for ranging using simple formulas:

MOA RANGING FORMULAS

$$\frac{\text{Target Size (Inches)} \times 95.5}{\text{Measured MOAs}} = \text{Range (Yards)}$$

$$\frac{\text{Target Size (CM)} \times 34.37}{\text{Measured MOAs}} = \text{Range (Meters)}$$

Using either the vertical or horizontal MOA scale, place the reticle on a target of known dimensions and read the number of MOAs spanned. You will obtain maximum accuracy in ranging by calculating exact MOA measurements. MOAs should be estimated in 1/4s if possible.

Accurate measuring will depend on a very steady hold. The rifle should be solidly braced using a rest, bipod or sling when measuring. Once you have an accurate MOA reading, use the formula to calculate the distance.

Note: In the MOA ranging formula, a shooter may substitute 100 for 95.5 in the interest of speedier calculations. Be aware that this will produce a five percent over-estimation error of the yardage distance obtained.

Example

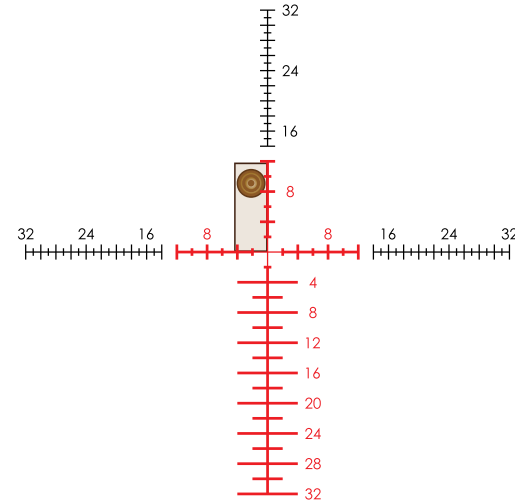

Ranging a 6-foot target (72 inches) at 12 MOAs yields 573 yards. Illustration shown is the 2-10 x 32.

$$\frac{72 \times 95.5}{12 \text{ MOA}} = 573 \text{ Yards}$$

ELEVATION HOLDOVERS

Once the distance has been calculated using the reticle or a laser rangefinder, the reticle can be used for rapid holdover correction for bullet drop of the cartridge being used. To get the most benefit out of the EBR equipped riflescope, Vortex Optics highly recommends shooters learn their bullet drop numbers in MOAs rather than inches.

Since these reticles are scaled in MOAs, it is an easy job to quickly select the correct drop reference line once the shooter knows the bullet drops and windage/lead corrections in MOAs. If the shooter prefers to dial come ups for bullet drop using the elevation knob, knowing bullet drops in MOAs will allow for much faster adjustments as the MOAs can be quickly read on the elevation knob.

Example

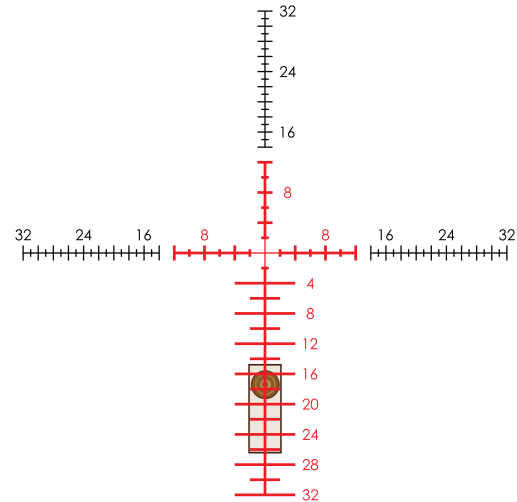

17.5 MOA reticle holdover at 625 yards. No wind.
Illustration shown is the 2-10 x 32.

WINDAGE AND MOVING TARGETS

The EBR MOA reticle is highly effective when used for wind and moving target leads. Using the reticle for effective windage and moving target leads will require thorough knowledge of your weapons system's ballistic performance under varying conditions and experience in reading wind strengths and target speeds. As in bullet drops, it is important for the shooter to learn a particular weapon's windage/moving target corrections in MOAs rather than inches. Always hold the reticle into the wind.

Basic windage correction on center crosshair

When dialing elevation come ups, the center horizontal crosshair will be used for windage or moving lead corrections.

Example

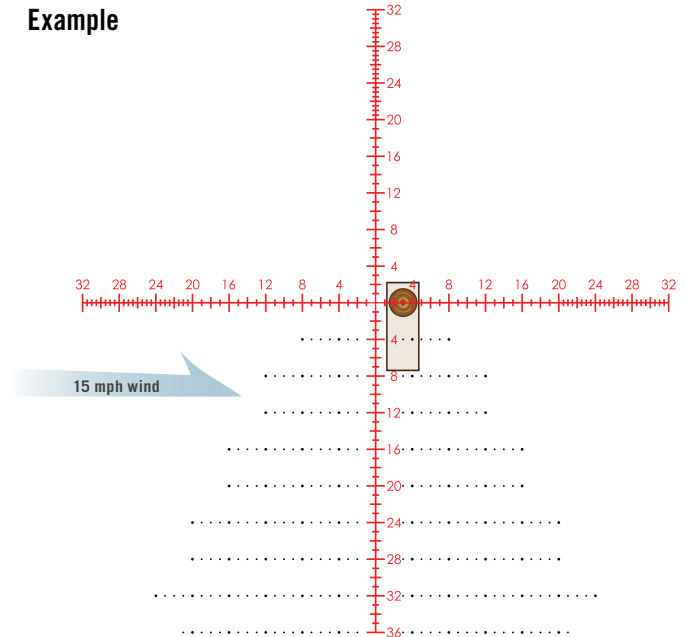

3 MOA correction for 15 mph wind at 700 yards. Elevation already dialed into turret. Illustration shown is the 3-15 x 44.

BASIC WINDAGE CORRECTION USING DROP LINE ON RETICLE

When using the reticle for elevation correction rather than dialing, the MOA marks on the center horizontal crosshair can still be used to help visually reference windage corrections.

Example

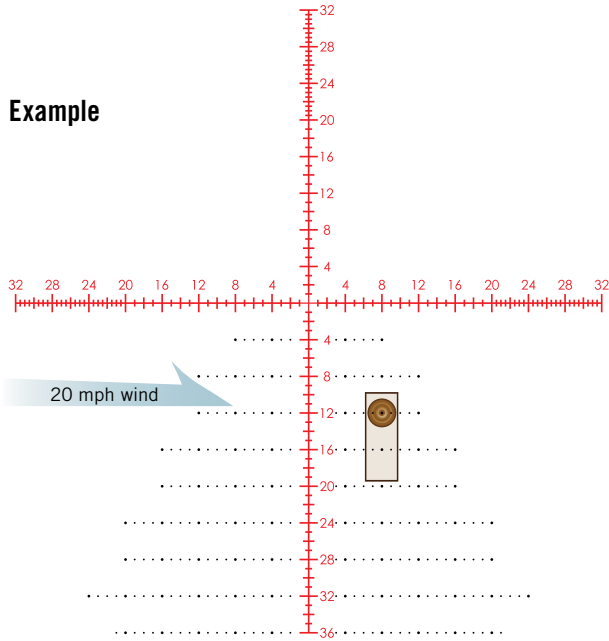

8 MOA reticle windage correction at 500 yards in 20 mph crosswind using 12 MOA reticle drop line. Illustration shown is the 3-15 x 44.

Basic moving lead correction

When estimating moving target leads, the MOA marks on the center horizontal crosshair can be used. Estimating moving leads will require knowing yardage distance, wind speed, moving target speed and total bullet flight times including rifle lock time. Bullet flight times can be roughly calculated based on fps velocities or a ballistic calculator.

Note: Correctly estimating moving leads is very difficult and requires considerable practice and knowledge beyond the scope of this manual.

Example

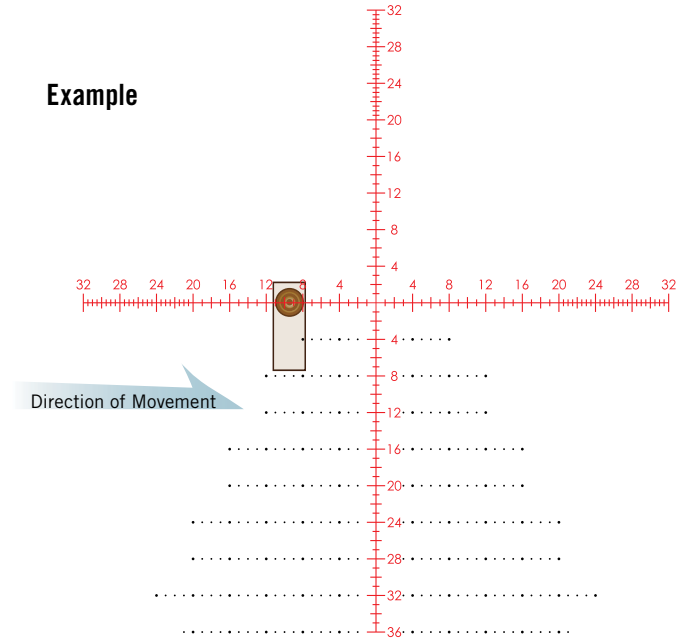

9.4 MOA reticle correction for a target moving at 3 mph at 800 yards. No wind. Illustration shown is the 5-25 x 50.

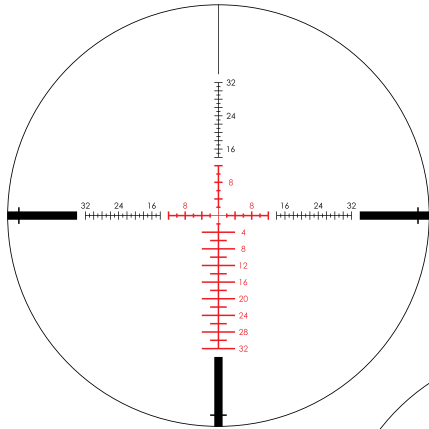

2-10 x 32 EBR-4

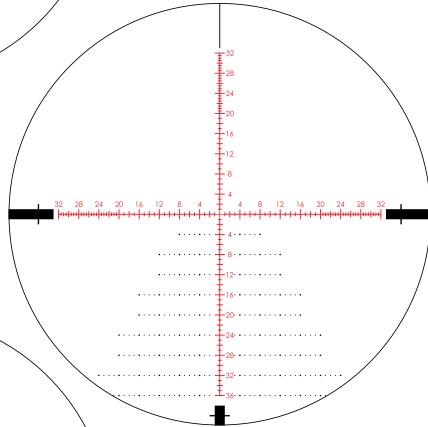

3-15 x 44 EBR-2C

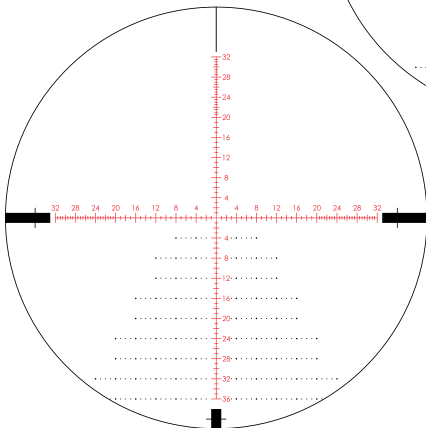

5-25 x 50 EBR-2C

Shown at maximum magnification



VIP WARRANTY

OUR UNCONDITIONAL PROMISE TO YOU.

We promise to repair or replace the product. Absolutely free.

- ▶ **Unlimited**
- ▶ **Unconditional**
- ▶ **Lifetime Warranty**

Learn more at www.VortexOptics.com

service@VortexOptics.com • 800-426-0048

Note: The VIP Warranty does not cover loss, theft, deliberate damage, or cosmetic damage not affecting product performance.

